

일반헬스(기초용) H : 1800

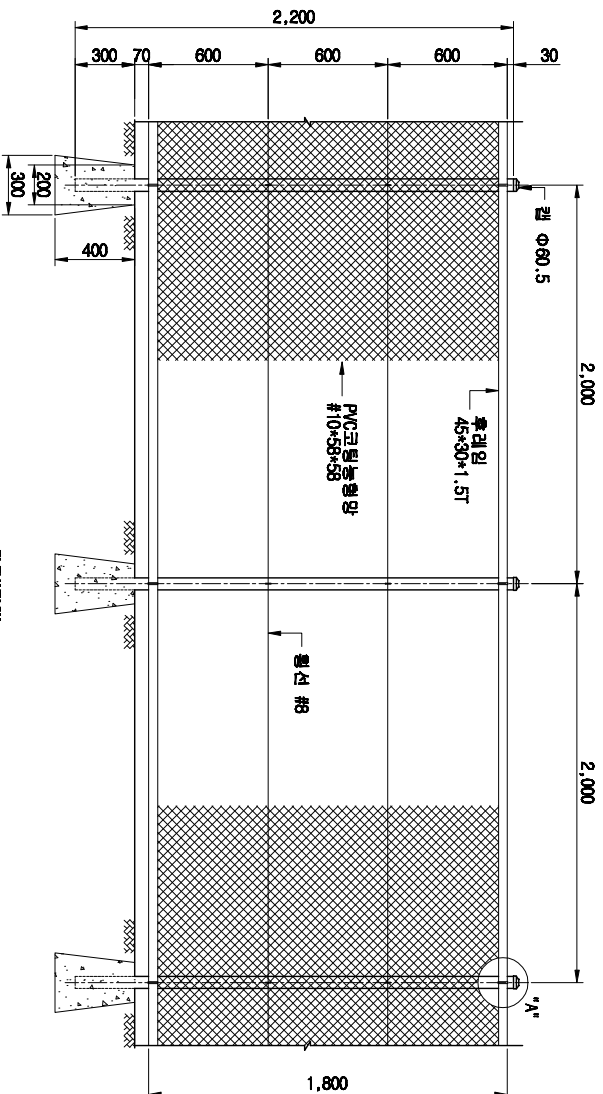

ELEVATION
SCALE : NONE

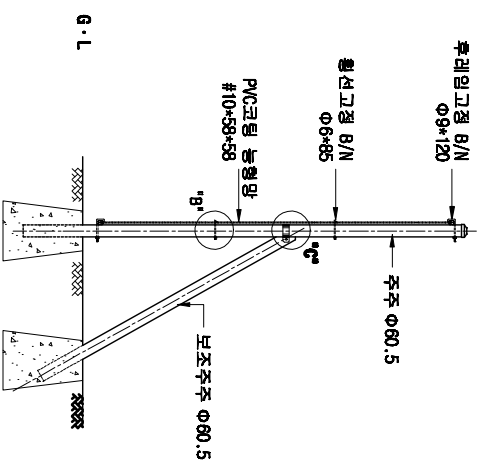

SIDE ELEVATION
SCALE : NONE

재료표

1개간 (규격 : H1.8 * 2.0)

품 목	구 격	단위	수량	비 고
주주	Φ80.5	#	2.2	충당도#
헬선	Φ80.5#8	EA	1	충당도#
주리임	45*30*1.5T	#	4	충당도#
망고정면	40*30*180*2.9T	EA	1	충당도#
PVC코팅 능형망	#10*58*58	22	3.8	PVC코팅
헬선	#8	#	8	PVC코팅
주리임고경 B/N	Φ9*120	EA	2	아연도금
헬선고경 B/N	Φ8*85	EA	2	아연도금
망고정면	5T27	EA	14	5T8
보조주주	Φ80.5	#	0.3	충당도#
보조주주밴드	Φ80.5#8	EA	0.2	충당도#
보조주주밴드B/N	Φ9*40	EA	0.2	충당도#

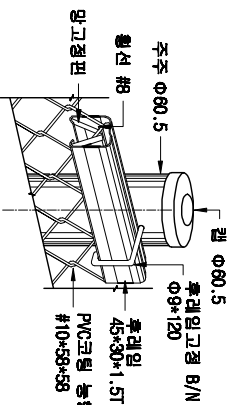

A-A 상세도
SCALE : NONE

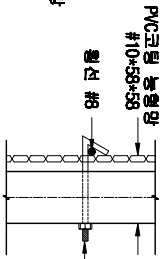

B-B 상세도
SCALE : NONE

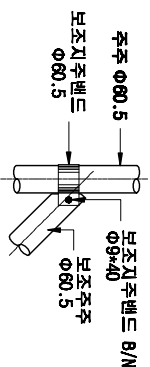

C-C 상세도
SCALE: NONE

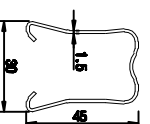

주리임 단면 상세도
SCALE : NONE

도면명 Drawing	일반용 헬스	설계 Design	날짜	도면번호
공사명 Project		제도 Drawing	축척	일반헬스 H=1800
			NONE	

(주)남영헬스
 TEL: 053)957-4854
 FAX: 053)957-4288
 [712-837]경북 경산시 진량읍 신상리 1180-20